

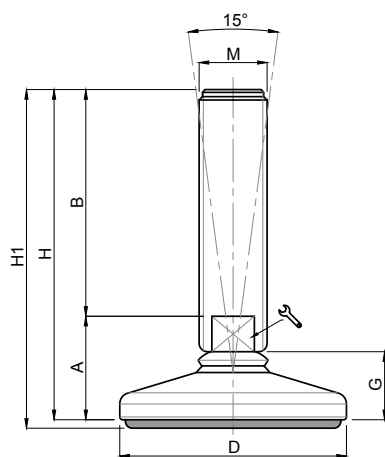





















Embases inox massif

Ø 60

Embase inox
Tige inox
Pied articulé oscillant

CODE		DÉSIGNATION	DIMENSIONS								CHARGE MAXI
Standard	avec semelle		D	M	B		G	A	H	H1	Newton
MA-20000	MA-20001	M12x50	60	M12	50	12 	24	34	84	87	20 000
MA-20002	MA-20003	M12x75	60	M12	75	12 	24	34	109	112	20 000
MA-20004	MA-20005	M12x100	60	M12	100	12 	24	34	134	137	20 000
MA-20006	MA-20007	M12x125	60	M12	125	12 	24	34	159	162	20 000
MA-20008	MA-20009	M12x150	60	M12	150	12 	24	34	184	187	20 000
MA-20010	MA-20011	M12x175	60	M12	175	12 	24	34	209	212	20 000
MA-20022	MA-20023	M16x75	60	M16	75	13 	24	34	109	112	30 000
MA-20024	MA-20025	M16x100	60	M16	100	13 	24	34	134	137	30 000
MA-20026	MA-20027	M16x125	60	M16	125	13 	24	34	159	162	30 000
MA-20028	MA-20029	M16x150	60	M16	150	13 	24	34	184	187	30 000
MA-20030	MA-20031	M16x175	60	M16	175	13 	24	34	209	212	30 000
MA-20032	MA-20033	M16x200	60	M16	200	13 	24	34	234	237	30 000
MA-20034	MA-20035	M16x225	60	M16	225	13 	24	34	259	262	30 000
MA-20036	MA-20037	M16x250	60	M16	250	13 	24	34	284	287	30 000
MA-20042	MA-20043	M20x100	60	M20	100	17 	24	36	136	139	35 000
MA-20044	MA-20045	M20x125	60	M20	125	17 	24	36	161	164	35 000
MA-20046	MA-20047	M20x150	60	M20	150	17 	24	36	186	189	35 000
MA-20048	MA-20049	M20x175	60	M20	175	17 	24	36	211	214	35 000
MA-20050	MA-20051	M20x200	60	M20	200	17 	24	36	236	239	35 000
MA-20052	MA-20053	M20x225	60	M20	225	17 	24	36	261	264	35 000
MA-20054	MA-20055	M20x250	60	M20	250	17 	24	36	286	289	35 000

matière

Embase en inox AISI 304 (316 sur demande).
Tige en inox AISI 304 (316 sur demande) livrée sans écrou.
Semelle en caoutchouc NBR dureté 70° shore.

note

Réalisation de dimensions et finitions spéciales de tiges filetées dès 200 pièces.

