

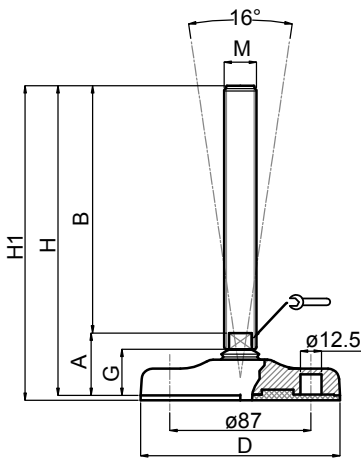















Embases plastique & caoutchouc

Ø 123

Embase extra plate technopolymère
Tige inox
Pied articulé oscillant fixeable

Version acier p. 16



CODE		DÉSIGNATION	DIMENSIONS								CHARGE MAXI	
Standard	avec semelle		A	B	D		M	G	H	H1	Newton	
MA-18310	MA-18311	M16x100	39	100	123	13		M16	29	139	143	35 000
MA-18314	MA-18315	M16x150	39	150	123	13		M16	29	189	193	35 000
MA-18318	MA-18319	M16x200	39	200	123	13		M16	29	239	243	35 000
MA-18322	MA-18323	M20x100	41	100	123	17		M20	29	141	145	35 000
MA-18326	MA-18327	M20x150	41	150	123	17		M20	29	191	195	35 000
MA-18330	MA-18331	M20x200	41	200	123	17		M20	29	241	245	35 000
MA-18334	MA-18335	M20x250	41	250	123	17		M20	29	291	295	35 000
MA-18338	MA-18339	M24x100	41	100	123	20		M24	29	141	145	35 000
MA-18342*	MA-18343*	M24x150	41	150	123	20		M24	29	191	195	35 000
MA-18346*	MA-18347*	M24x200	41	200	123	20		M24	29	241	245	35 000
MA-18350	MA-18351	M24x250	41	250	123	20		M24	29	291	295	35 000
MA-18354	MA-18355	M30x100	41	100	123	26		M30	29	141	145	35 000
MA-18358*	MA-18359*	M30x150	41	150	123	26		M30	29	191	195	35 000
MA-18362*	MA-18363*	M30x200	41	200	123	26		M30	29	241	245	35 000
MA-18366	MA-18367	M30x250	41	250	123	26		M30	29	291	295	35 000

* Référence disponible au pas fin (code + P2)

matière

Embase en technopolymère noir mat renforcé fibre de verre.
Tige en inox AISI 304 (316 sur demande) livrée sans écrou. Semelle en caoutchouc NBR dureté 70° shore.
Sur demande support livré sans semelle (code standard).

note

Votre embase couleur RAL dès 1 500 pièces.
Réalisation de dimensions et finitions spéciales de tiges filetées dès 200 pièces.
Semelle spéciale (EPDM, nitrile, caoutchouc anti-trace...) sur demande.

